

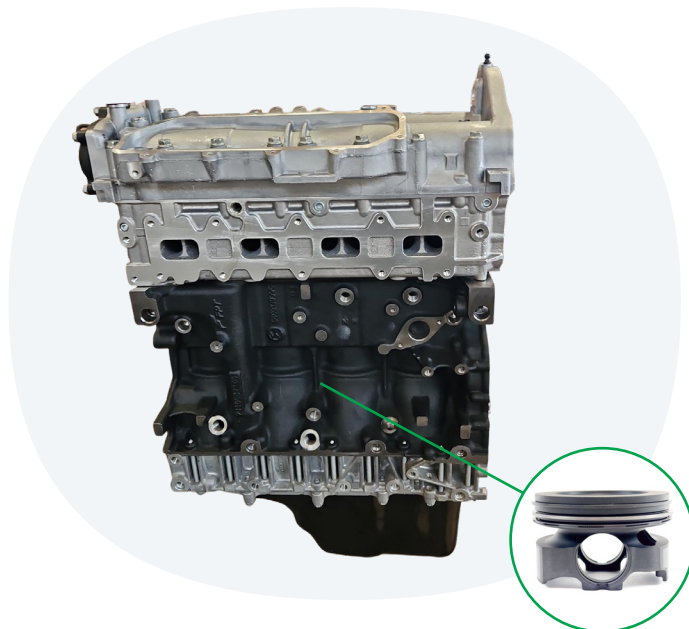

**Catalogo ricambi / Spare parts catalogue
DAILY Euro 6E MY. 22/24 - Motore F1AGL411**

Pistone in acciaio / Steel Piston

Motori Semicompleti Longblock



DUBHE REF. **90620**

OE Ref.

Applicazione
Application DAILY Euro 6E MY.22/24 - FIAGL411

Nota 1
Note 1 Coppa olio in lamiera
Sheet metal oil pan

Nota 2
Note 2 Per cambio manuale
For manual transmission

Nota 3
Note 3 Pistone in acciaio
Steel Piston

Motori Semicompleti Longblock

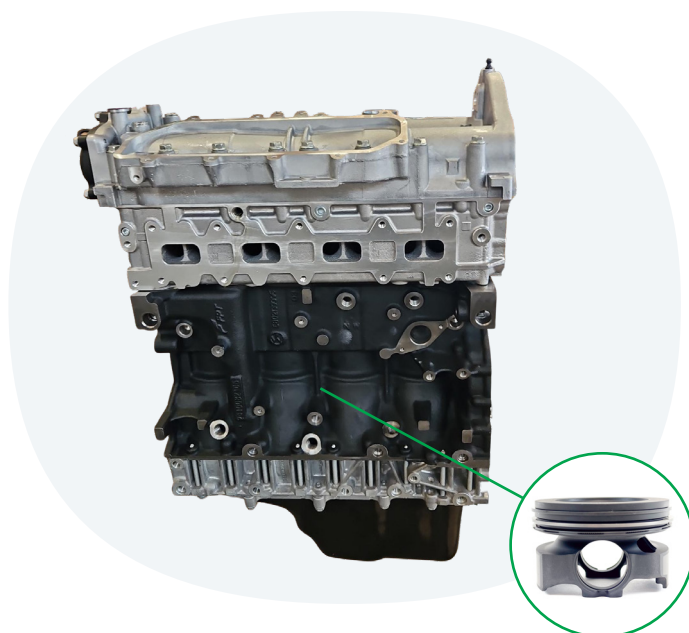

DUBHE REF. **90640**

OE Ref.

Applicazione
Application DAILY Euro 6E MY.22/24 - FIAGL411

Nota 1
Note 1 Coppa olio in lamiera
Sheet metal oil pan

Nota 2
Note 2 Per cambio automatico
For automatic transmission

Nota 3
Note 3 Pistone in acciaio
Steel Piston

Motori Semicompleti Longblock

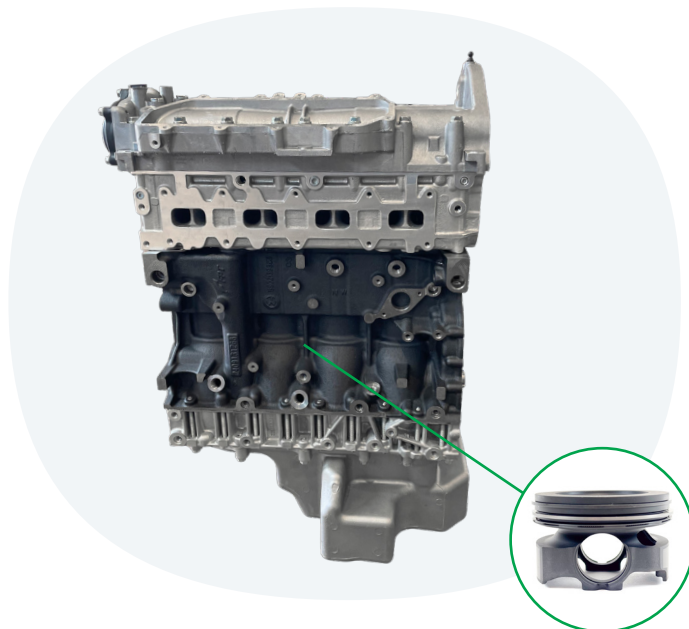

DUBHE REF. **90680**

OE Ref.

Applicazione
Application DAILY Euro 6E MY.22/24 - FIAGL411

Nota 1
Note 1 Coppa in alluminio
Aluminium oil pan

Nota 2
Note 2 Per cambio manuale
For manual transmission

Nota 3
Note 3 Pistone in acciaio
Steel Piston

Motori Semicompleti Longblock

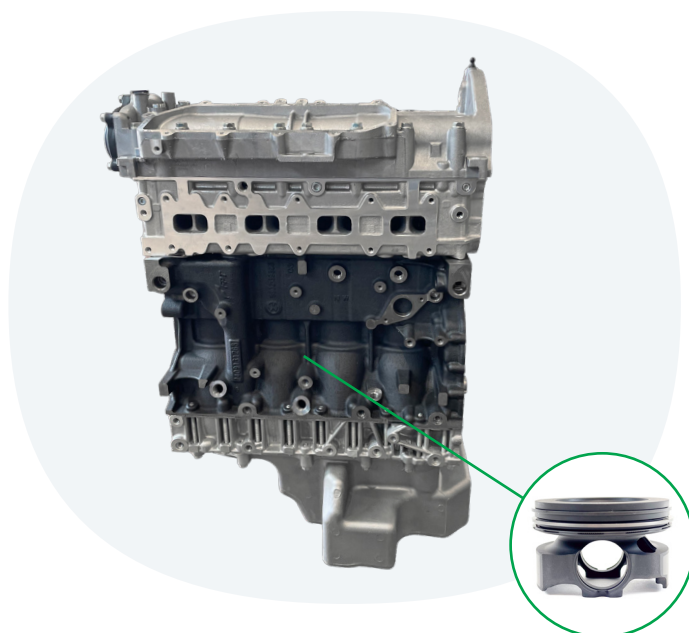

DUBHE REF. **90690**

OE Ref.

Applicazione
Application DAILY Euro 6E MY.22/24 - FIAGL411

Nota 1
Note 1 Coppa in alluminio
Aluminium oil pan

Nota 2
Note 2 Per cambio automatico
For automatic transmission

Nota 3
Note 3 Pistone in acciaio
Steel Piston

Motori Alleggeriti Shortblock

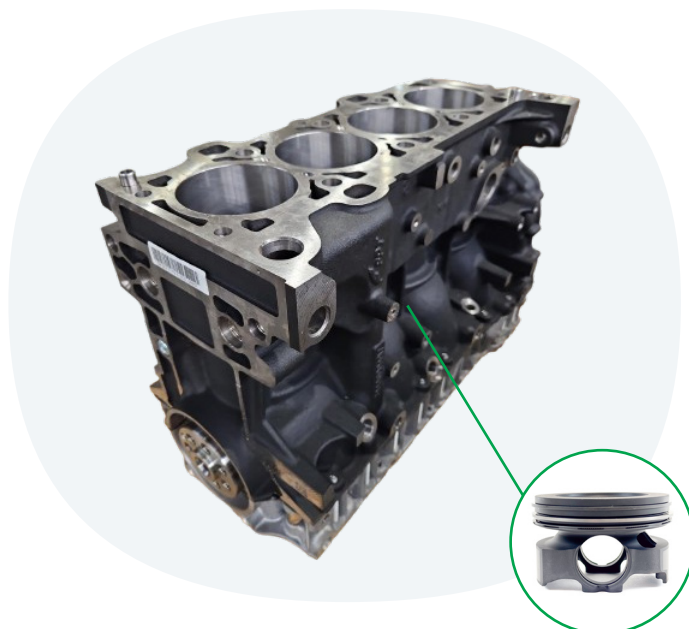

DUBHE REF. **81150**

OE Ref.

Applicazione
Application DAILY Euro 6E MY.22/24 - FIAGL411

Nota 1
Note 1 Per cambio manuale
For manual transmission

Nota 2
Note 2 Pistone in acciaio
Steel Piston

Motori Alleggeriti Shortblock

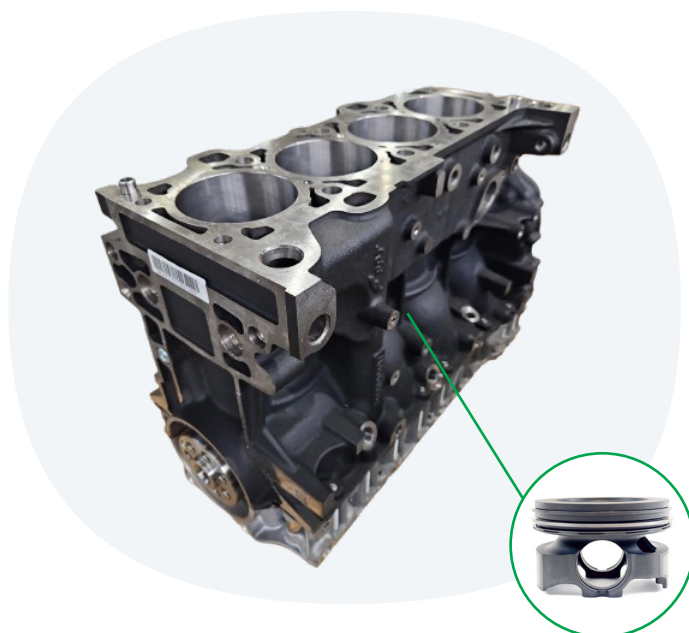

DUBHE REF. **81170**

OE Ref.

Applicazione
Application DAILY Euro 6E MY.22/24 - FIAGL411

Nota 1
Note 1 Per cambio automatico
For automatic transmission

Nota 2
Note 2 Pistone in acciaio
Steel Piston

Monoblocco
Crankcase

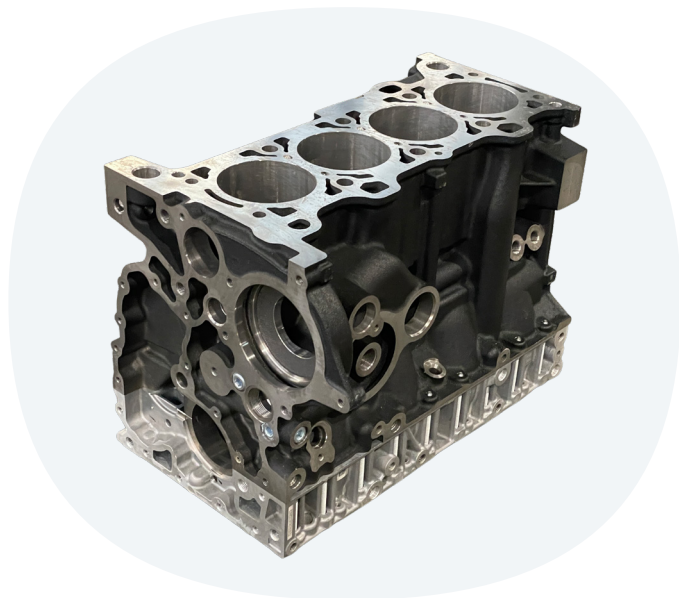

DUBHE REF. **30286**

OE Ref. 5803436090

Applicazione
Application DAILY Euro 6E MY.22/24 - FIAGL411

Testata
Cylinder Head



DUBHE REF. **102680**

OE Ref. 5802826548

Applicazione
Application DAILY Euro 6E MY.22/24 - FIAGL411

Copritestata
Cylinder Head Cover

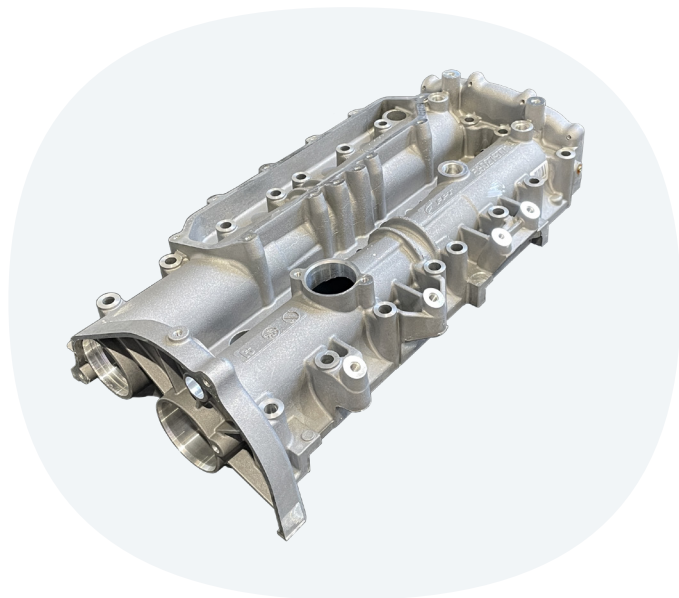

DUBHE REF. **272060**

OE Ref. 5802797713

Applicazione
Application DAILY Euro 6E MY.22/24 - FIAGL411

Guarnizione, Copritestata
Gasket, cylinder head cover

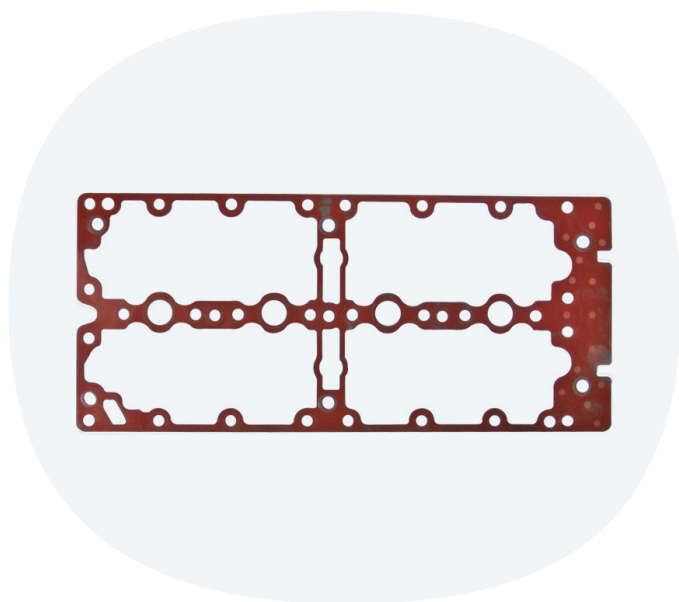

DUBHE REF. **LEM20054.01**

OE Ref. 504052452

Applicazione
Application DAILY Euro 6E MY.22/24 - FIAGL411

Copritestata
Cylinder Head Cover

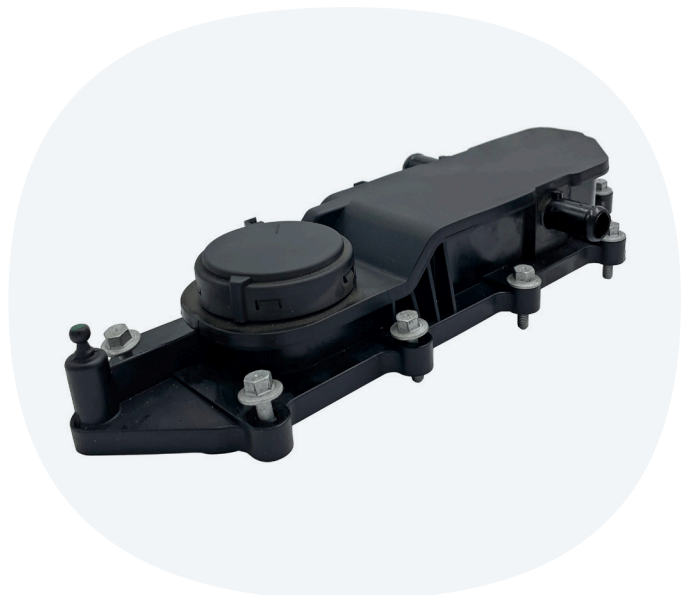

DUBHE REF. **949390M**

OE Ref. 504132147

Applicazione
Application DAILY Euro 6E MY.22/24 - FIAGL411

Albero a camme
Camshaft



DUBHE REF. **20650M**

OE Ref. 504096183

Applicazione
Application DAILY Euro 6E MY.22/24 - FIAGL411

Nota 1
Note 1 Lato scarico
Exhaust side

Albero a camme Camshaft



DUBHE REF. **20640M**

OE Ref. 504096185

Applicazione
Application DAILY Euro 6E MY.22/24 - FIAGL411

Nota 1
Note 1 Lato aspirazione
Intake side

Kit catena distribuzione Timing Chain Kit



DUBHE REF. **946411**

OE Ref. 504068388

Applicazione
Application DAILY Euro 6E MY.22/24 - FIAGL411

Coperchio di chiusura, Albero a camme
Locking Cover, camshaft



DUBHE REF. **912250M**

OE Ref. 504016456

Applicazione
Application DAILY Euro 6E MY.22/24 - FIAGL411

Paraolio, Albero a camme
Shaft Seal, camshaft



DUBHE REF. **LEM12017215**

OE Ref. 500350049

Applicazione
Application DAILY Euro 6E MY.22/24 - FIAGL411

Copritestata
Cylinder Head Cover



DUBHE REF. **270520M**

OE Ref. 500389605

Applicazione
Application DAILY Euro 6E MY.22/24 - FIAGL411

Seeger
Circlip



DUBHE REF. **131530**

OE Ref. 16873574

Applicazione
Application DAILY Euro 6E MY.22/24 - FIAGL411

Nota 1
Note 1 M14X1,5

Punteria
Rocker/ Tappet



DUBHE REF. **220350M**

OE Ref. 504014269

Applicazione
Application DAILY Euro 6E MY.22/24 - FIAGL411

Bullone testata
Cylinder Head Bolt



DUBHE REF. **481210**

OE Ref. 504081515

Applicazione
Application DAILY Euro 6E MY.22/24 - FIAGL411

Nota 1
Note 1 M15X1,5X192

Bullone testata
Cylinder Head Bolt



DUBHE REF. **480330**

OE Ref. 500347040

Applicazione
Application DAILY Euro 6E MY.22/24 - FIAGL411

Nota 1
Note 1 M11X1,5X132

Kit bulloni testata
Bolt Kit, cylinder head



DUBHE REF. **483025**

OE Ref.

Applicazione
Application DAILY Euro 6E MY.22/24 - FIAGL411

Nota 1
Note 1 M15X192 6PZ + M11X132 4PZ

Cinghia dentata
Timing Belt



DUBHE REF. **292320**

OE Ref. 5802797811

Applicazione
Application DAILY Euro 6E MY.22/24 - FIAGL411

Rullo tenditore, Cinghia dentata
Tensioner Pulley, timing belt



DUBHE REF. **386790**

OE Ref. 5802985450

Applicazione
Application DAILY Euro 6E MY.22/24 - FIAGL411

Galoppino/Guidacinghia, Cinghia dentata
Deflection/Guide Pulley, timing belt



DUBHE REF. **HB302**

OE Ref. 500388688

Applicazione
Application DAILY Euro 6E MY.22/24 - FIAGL411

Galoppino/Guidacinghia, Cinghia dentata
Deflection/Guide Pulley, timing belt



DUBHE REF. **380949**

OE Ref. 500388688

Applicazione
Application DAILY Euro 6E MY.22/24 - FIAGL411

Guarnizione, Testata
Gasket, cylinder head



DUBHE REF.	LEM10061.02
OE Ref.	5801841070
Applicazione Application	DAILY Euro 6E MY.22/24 - FIAGL411
Nota 1 Note 1	Spessore: 1,1 mm Thickness: 1,1 mm

Guarnizione, Testata
Gasket, cylinder head

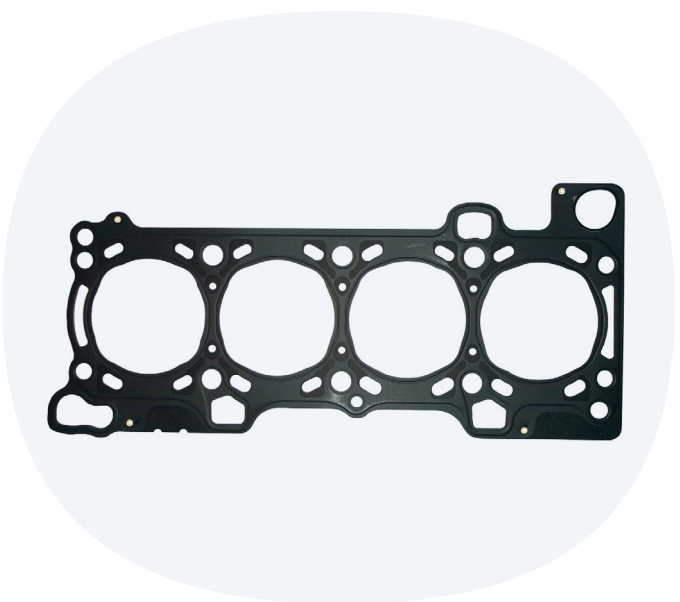

DUBHE REF.	LEM10061.00
OE Ref.	500387068
Applicazione Application	DAILY Euro 6E MY.22/24 - FIAGL411
Nota 1 Note 1	Spessore: 1,2 mm Thickness: 1,2 mm

Guarnizione, Testata
Gasket, cylinder head

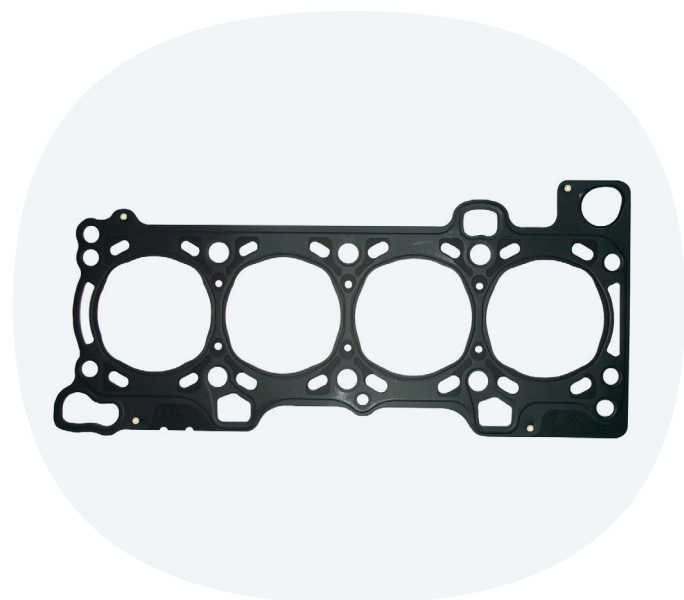

DUBHE REF.	LEM10061.01
OE Ref.	500387069
Applicazione Application	DAILY Euro 6E MY.22/24 - FIAGL411
Nota 1 Note 1	Spessore: 1,3 mm Thickness: 1,3 mm

Kit guarnizioni, Testata
Gasket Set, cylinder head

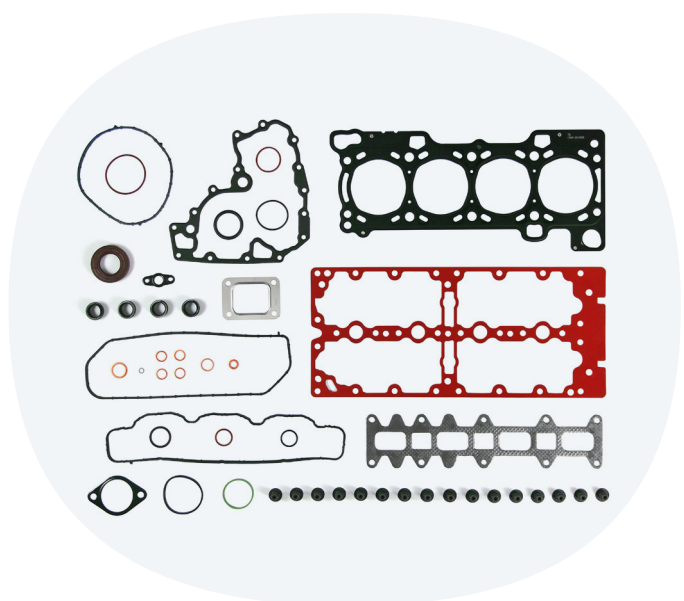

DUBHE REF.	LEM44056.03
OE Ref.	
Applicazione Application	DAILY Euro 6E MY.22/24 - FIAGL411
Nota 1 Note 1	Con guarniz. testa spessore: 1,2 mm With cylinder head gasket thickness: 1,2 mm

Kit guarnizioni, Testata
Gasket Set, cylinder head

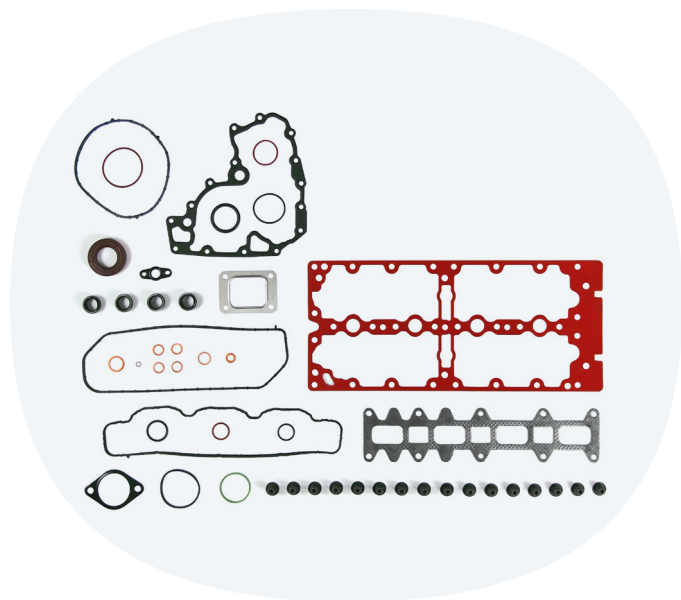

DUBHE REF. **LEM46056.03**

OE Ref.

Applicazione
Application DAILY Euro 6E MY.22/24 - FIAGL411

Nota 1
Note 1 Senza guarnizione testa
Without cylinder head gasket

Kit completo guarnizioni, Motore
Full Gasket Set, engine

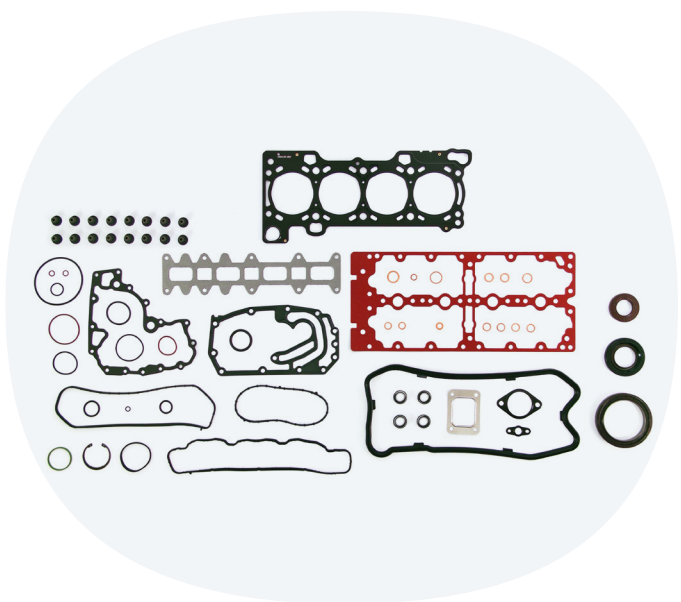

DUBHE REF. **LEM38056.03**

OE Ref.

Applicazione
Application DAILY Euro 6E MY.22/24 - FIAGL411

Nota 1
Note 1 Con guarniz. testa spessore: 1,2 mm
With cylinder head gasket thickness: 1,2 mm

Collettore d'aspirazione, Alimentazione aria
Intake Manifold, air supply



DUBHE REF. **7370399**

OE Ref. 504384189

Applicazione
Application DAILY Euro 6E MY.22/24 - FIAGL411

Guarnizione, Alloggiam. collettore aspirazione
Gasket, intake manifold housing

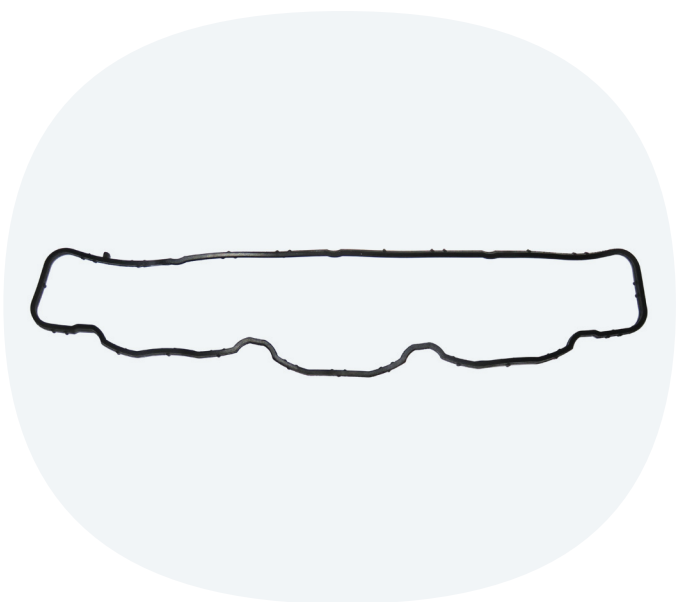

DUBHE REF. **LEM21008.21**

OE Ref. 5801484362

Applicazione
Application DAILY Euro 6E MY.22/24 - FIAGL411

Corpo farfallato
Throttle body

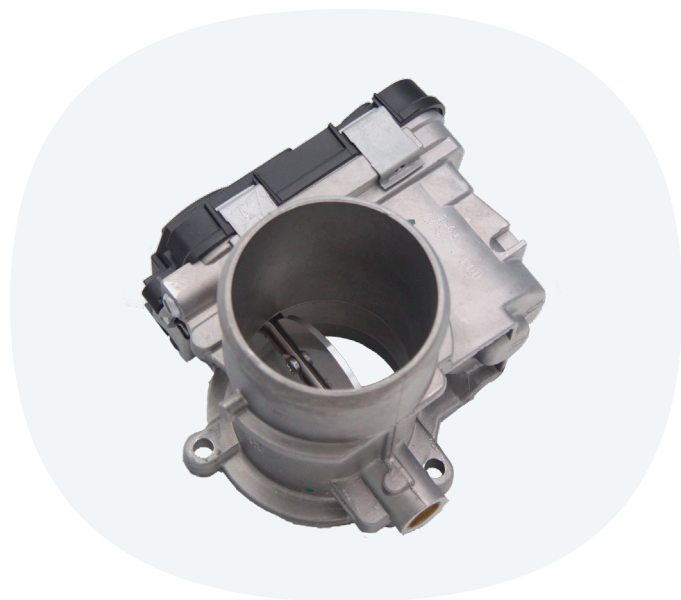

DUBHE REF. **947800**

OE Ref. 5802712012

Applicazione
Application DAILY Euro 6E MY.22/24 - FIAGL411

Guarnizione, Collettore aspirazione/scarico
Gasket, intake/ exhaust manifold

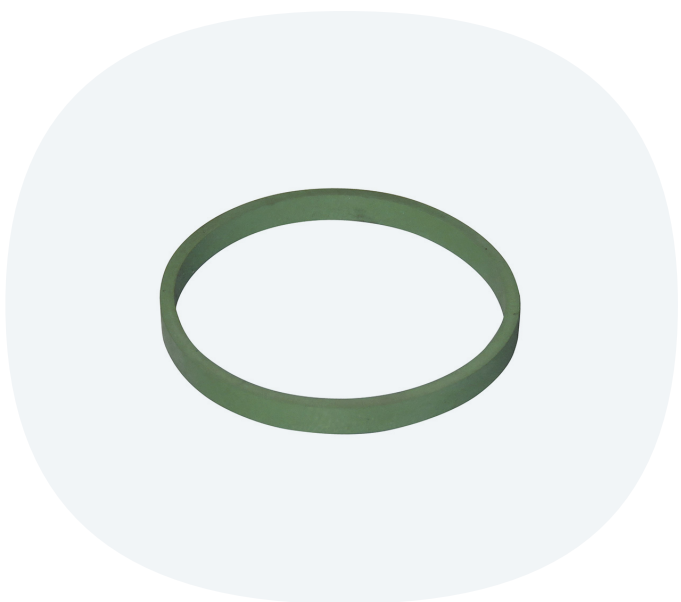

DUBHE REF. **LEM21008.22**

OE Ref. 5801484364

Applicazione
Application DAILY Euro 6E MY.22/24 - FIAGL411

Collettore, Impianto gas scarico
Collector, exhaust system



DUBHE REF. **563780**

OE Ref. 5802830651

Applicazione
Application DAILY Euro 6E MY.22/24 - FIAGL411

Guarnizione, Collettore gas scarico
Gasket, exhaust manifold

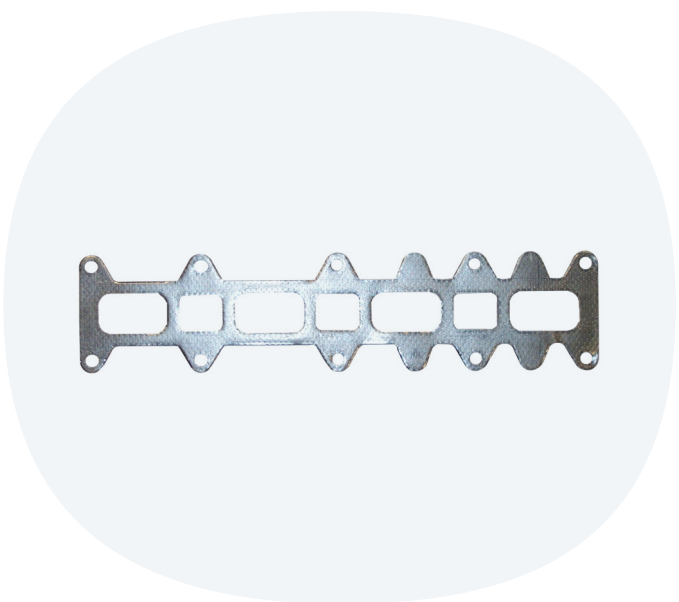

DUBHE REF. **LEM21509.00**

OE Ref. 5802114203

Applicazione
Application DAILY Euro 6E MY.22/24 - FIAGL411

Paraolio, Albero a gomiti
Shaft Seal, crankshaft



DUBHE REF.	LEM20034613
OE Ref.	504087648
Applicazione Application	DAILY Euro 6E MY.22/24 - FIAGL411
Nota 1 Note 1	50 x 80 x 11
Nota 2 Note 2	Lato anteriore Front side

Paraolio, Albero a gomiti
Shaft Seal, crankshaft



DUBHE REF.	LEM12019602
OE Ref.	504101720
Applicazione Application	DAILY Euro 6E MY.22/24 - FIAGL411
Nota 1 Note 1	83 x 113 x 13/12,2
Nota 2 Note 2	Lato cambio Gearbox side

Valvola di aspirazione
Inlet Valve



DUBHE REF. **827020**

OE Ref. 504069199

Applicazione
Application DAILY Euro 6E MY.22/24 - FIAGL411

Nota 1
Note 1 30 x 6 x 120.4 - 45°

Valvola di scarico
Outlet valve



DUBHE REF. **827230**

OE Ref. 504378070

Applicazione
Application DAILY Euro 6E MY.22/24 - FIAGL411

Nota 1
Note 1 30 x 6 x 120.4 - 45°

Pistone Piston



DUBHE REF. **859440**

OE Ref. 500086915

Applicazione
Application DAILY Euro 6E MY.22/24 - FIAGL411

Nota 1
Note 1 D.88 / Pistone in acciaio
D.88 / Steel piston

Nota 2
Note 2 Vaschetta doppia 61/49mm
Double bowl combustion chamber: 61/49 mm

Kit fasce elastiche Piston Ring Kit



DUBHE REF. **819440**

OE Ref. 500086873

Applicazione
Application DAILY Euro 6E MY.22/24 - FIAGL411

Nota 1
Note 1 D.88 / 2 x 1.75 x 2

Biella Connecting Rod



DUBHE REF. **46661**

OE Ref. 5802819652

Applicazione
Application DAILY Euro 6E MY.22/24 - FIAGL411

Albero motore/a gomito Crankshaft

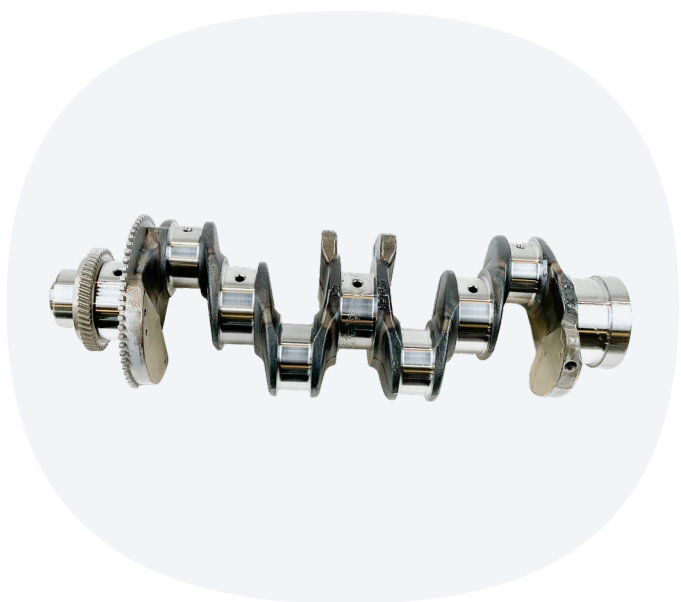

DUBHE REF. **19040M**

OE Ref. 5802744466

Applicazione
Application DAILY Euro 6E MY.22/24 - FIAGL411

Nota 1
Note 1 Innesto albero primario D.20mm
Input shaft pilot bore: 20mm

Nota 2
Note 2 Collo banco 68mm / Collo biella 56mm
Main journal 68mm / Rod journal 56mm

Albero motore/a gomito
Crankshaft

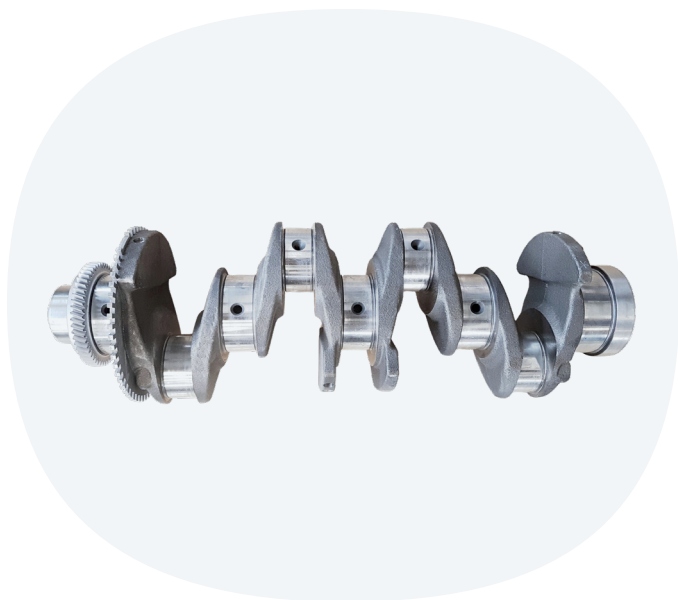

DUBHE REF. **10830**

OE Ref. 5801925563

Applicazione
Application DAILY Euro 6E MY.22/24 - FIAGL411

Nota 1
Note 1 Innesto albero primario D.21mm
Input shaft pilot bore: 21mm

Nota 2
Note 2 Collo banco 68mm / Collo biella 56mm
Main journal 68mm / Rod journal 56mm

Kit cuscinetto albero a gomiti
Crankshaft bearing Set



DUBHE REF. **848620M**

OE Ref. 500086038

Applicazione
Application DAILY Euro 6E MY.22/24 - FIAGL411

Nota 1
Note 1 STD

Kit cuscinetto albero a gomiti
Crankshaft bearing Set



DUBHE REF. **848621**

OE Ref. 500086156

Applicazione
Application DAILY Euro 6E MY.22/24 - FIAGL411

Nota 1
Note 1 0,25 mm

Bronzina di biella
Connecting Rod Bearing



DUBHE REF. **848690**

OE Ref. 500086170

Applicazione
Application DAILY Euro 6E MY.22/24 - FIAGL411

Nota 1
Note 1 STD

Kit bronzine di biella
Conrod Bearing Set



DUBHE REF. **848641**

OE Ref. 500086224

Applicazione
Application DAILY Euro 6E MY.22/24 - F1AGL411

Nota 1
Note 1 0,25 mm

Kit rettifica motore
Engine overhauling kit

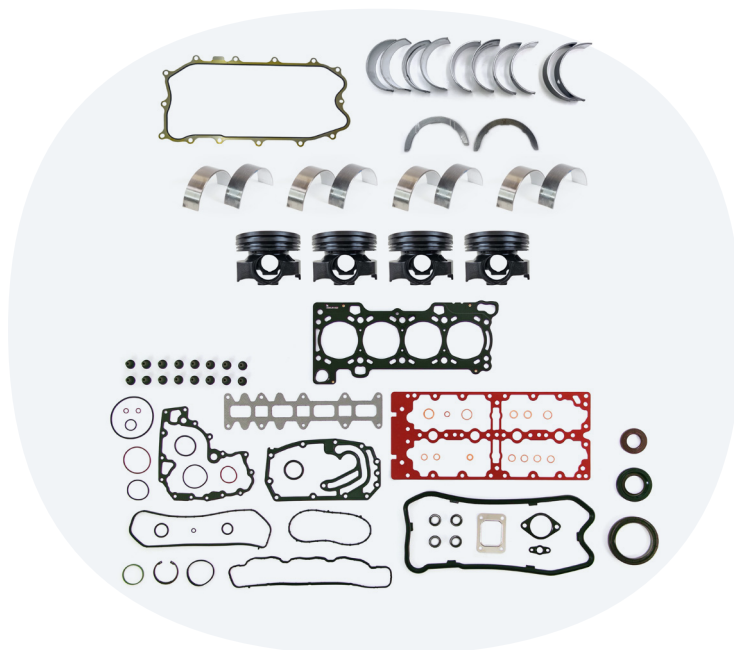

WITHOUT VALVES

Ø 88 MM

DUBHE REF. **789650**

Descrizione
Description

Kit rettifica motore - Engine overhauling kit

DAILY Euro 6E MY.22/24 - F1AGL411

Pistone in acciaio / Steel piston

Vaschetta doppia 61/49mm / Double bowl combustion chamber 61/49mm

789650
Senza valvole
Without valves

859440

x4

Pistone

Piston

848690

x4

Bronzina di biella

Connecting Rod Bearing

848620M

x1

Kit cuscinetto albero a gomiti

Crankshaft bearing Set

LEM10061.00

x1

Guarnizione, Testata

Gasket, cylinder head

LEM38056.03

x1

Kit completo guarnizioni, Motore

Full Gasket Set, engine

LEM25058.02

x1

Guarnizione, Coppa olio

Gasket, oil sump

Kit rettifica motore
Engine overhauling kit

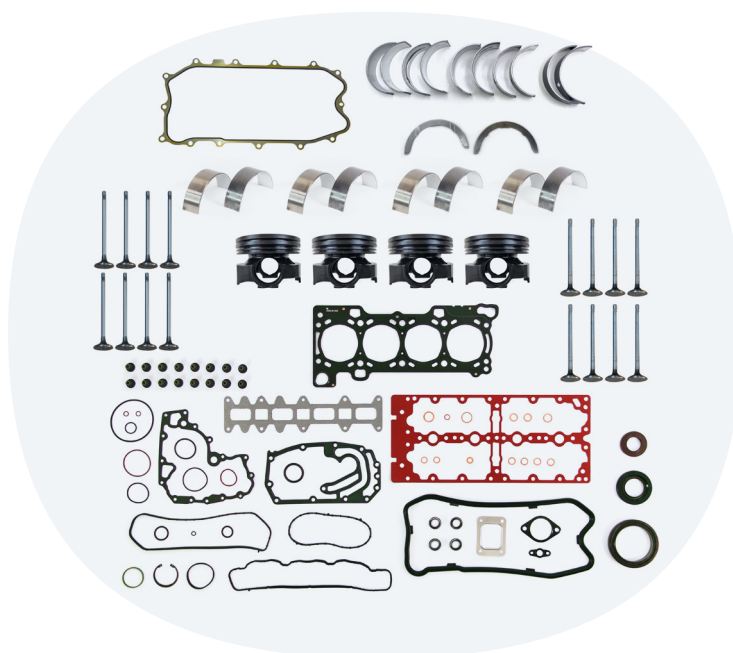

WITH VALVES

Ø 88 MM

DUBHE REF. **789655**

Descrizione
Description

Kit rettifica motore - Engine overhauling kit

DAILY Euro 6E MY.22/24 - F1AGL411

Pistone in acciaio / Steel piston

Vaschetta doppia 61/49mm / Double bowl combustion chamber 61/49mm

789655
Con valvole
With valves

859440

x4

Pistone

Piston

848690

x4

Bronzina di biella

Connecting Rod Bearing

848620M

x1

Kit cuscinetto albero a gomiti

Crankshaft bearing Set

LEM10061.00

x1

Guarnizione, Testata

Gasket, cylinder head

LEM38056.03

x1

Kit completo guarnizioni, Motore

Full Gasket Set, engine

LEM25058.02

x1

Guarnizione, Coppa olio

Gasket, oil sump

827020

x8

Valvola di aspirazione

Inlet valve

827230

x8

Valvola di scarico

Outlet valve

Coppa olio
Oil Sump

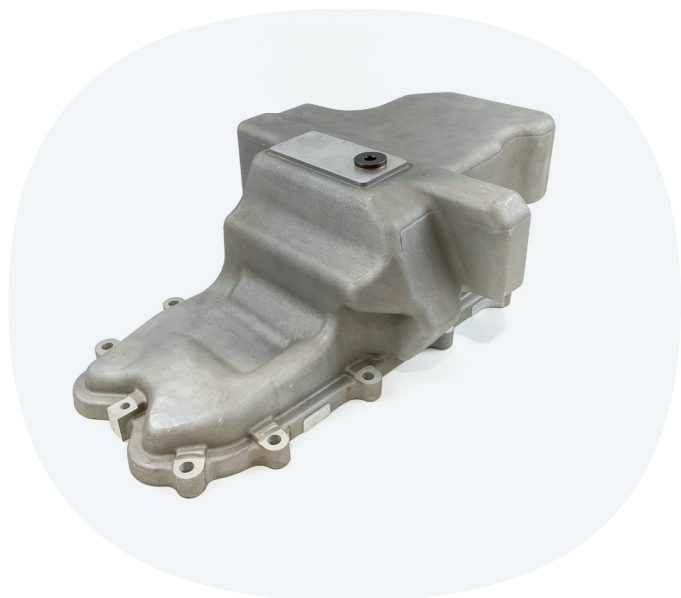

DUBHE REF. **192060M**

OE Ref. 5802391968

Applicazione
Application DAILY Euro 6E MY.22/24 - FIAGL411

Nota 1
Note 1 Alluminio
Aluminium

Guarnizione, Coppa olio
Gasket, oil sump

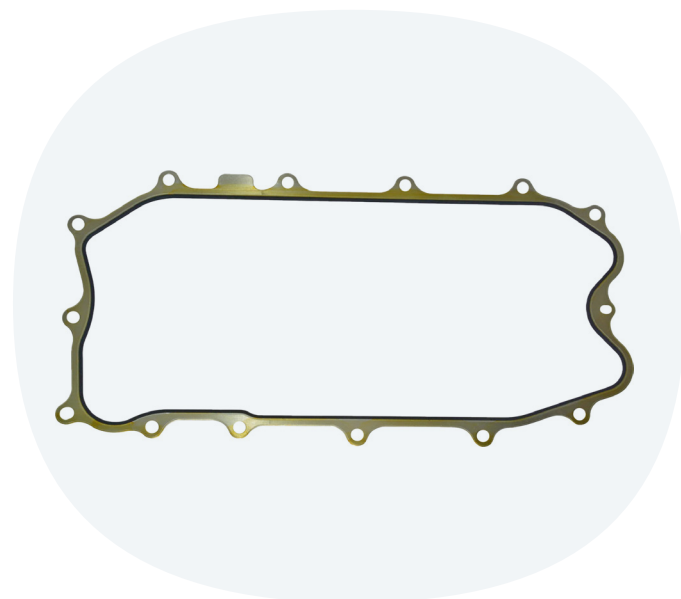

DUBHE REF. **LEM25058.02**

OE Ref. 5802391970

Applicazione
Application DAILY Euro 6E MY.22/24 - FIAGL411

Piastra di supporto per motori
Engine Transverse Strut



DUBHE REF. **133940**

OE Ref. 5802391975

Applicazione
Application DAILY Euro 6E MY.22/24 - FIAGL411

Coppa olio
Oil Sump



DUBHE REF. **192301**

OE Ref. 5802377332

Applicazione
Application DAILY Euro 6E MY.22/24 - FIAGL411

Nota 1
Note 1 Lamiera
Sheet metal

Guarnizione, Coppa olio
Gasket, oil sump

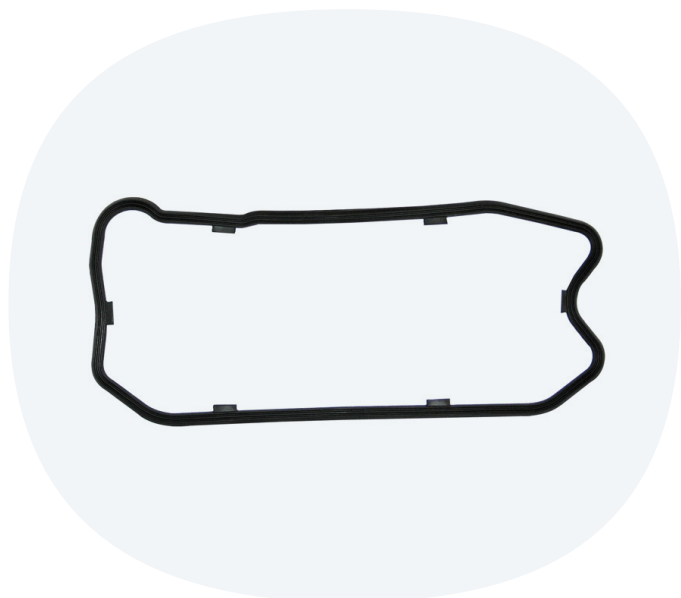

DUBHE REF. **LEM25058.01**

OE Ref. 504018307

Applicazione
Application DAILY Euro 6E MY.22/24 - FIAGL411

Collettore d'aspirazione, Pompa olio
Suction Pipe, oil pump



DUBHE REF. **130710M**

OE Ref. 504025477

Applicazione
Application DAILY Euro 6E MY.22/24 - FIAGL411

Anello di tenuta
Seal Ring



DUBHE REF.

LEM123095

OE Ref.

17282281

Applicazione
Application

DAILY Euro 6E MY.22/24 - FIAGL411

Tubazione
Pipe



DUBHE REF.

901525

OE Ref.

504018366

Applicazione
Application

DAILY Euro 6E MY.22/24 - FIAGL411

Pompa olio
Oil Pump

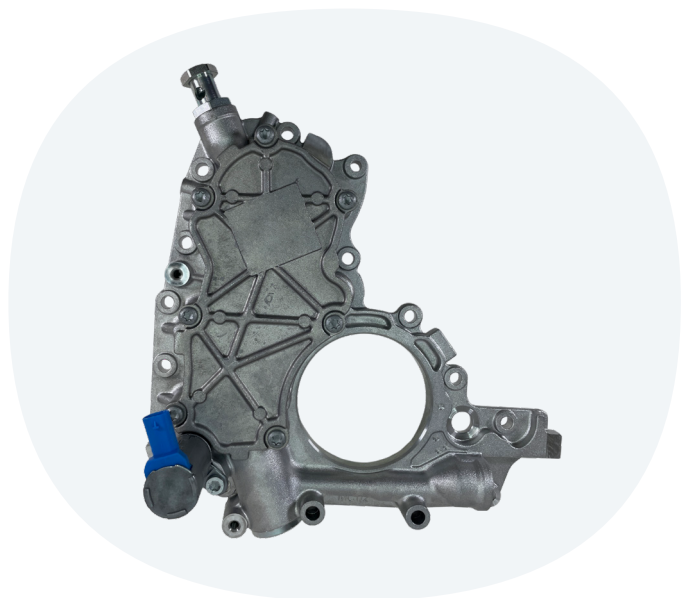

DUBHE REF. **142330M**

OE Ref. 5802804476

Applicazione
Application DAILY Euro 6E MY.22/24 - FIAGL411

Guarnizione
Gasket

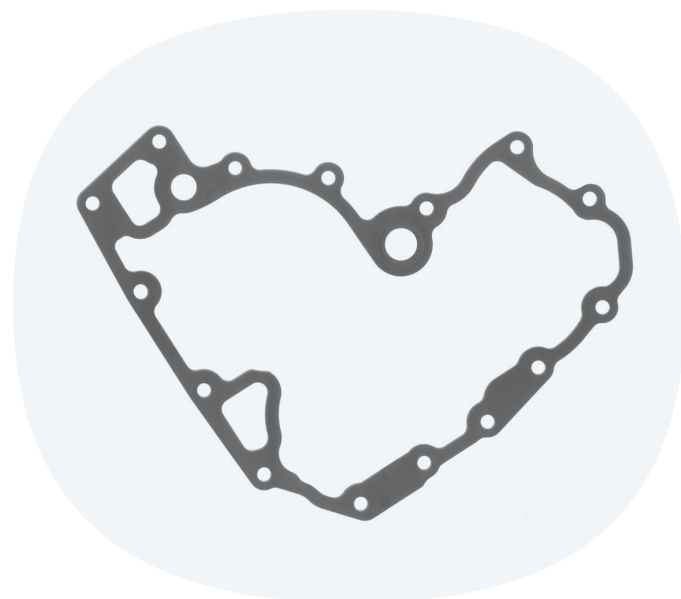

DUBHE REF. **LEM26280.10**

OE Ref. 504012746

Applicazione
Application DAILY Euro 6E MY.22/24 - FIAGL411

Ugello olio, Raffreddamento cielo pistone
Oil Jet, piston underside cooling



DUBHE REF. **970305**

OE Ref. 5802797642

Applicazione
Application DAILY Euro 6E MY.22/24 - FIAGL411

Radiatore olio, Olio motore
Oil Cooler, engine oil



DUBHE REF. **LEM650280**

OE Ref. 504375360

Applicazione
Application DAILY Euro 6E MY.22/24 - FIAGL411

Radiatore olio, Olio motore
Oil Cooler, engine oil



DUBHE REF. **650280**

OE Ref. 5801630223

Applicazione
Application DAILY Euro 6E MY.22/24 - FIAGL411

Corpo pompa acqua
Housing, water pump

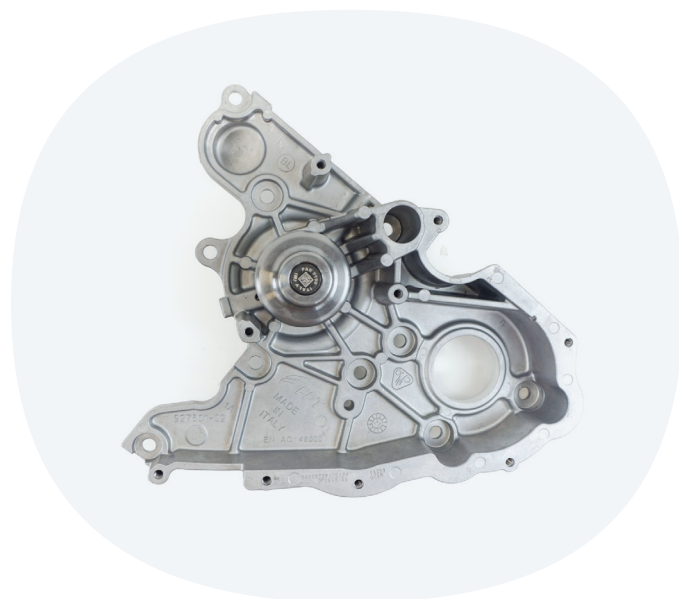

DUBHE REF. **357911**

OE Ref. 5802922937

Applicazione
Application DAILY Euro 6E MY.22/24 - FIAGL411

Anello di tenuta
Seal Ring



DUBHE REF. **LEM105100**

OE Ref. 17289680

Applicazione
Application DAILY Euro 6E MY.22/24 - FIAGL411

Nota 1
Note 1 3,53 x 44,45 mm

Anello di tenuta
Seal Ring



DUBHE REF. **LEM105280**

OE Ref. 17291280

Applicazione
Application DAILY Euro 6E MY.22/24 - FIAGL411

Nota 1
Note 1 3,53 x 98,02 mm

Termostato, Refrigerante
Thermostat, coolant

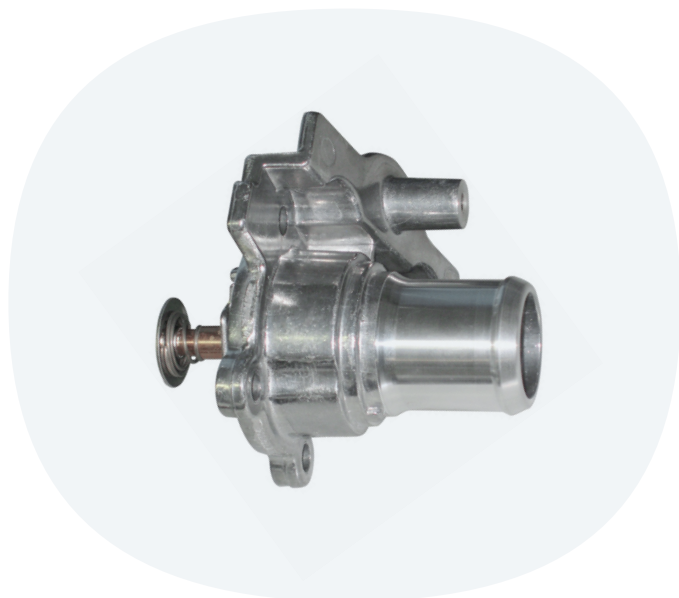

DUBHE REF. **LEM511582**

OE Ref. 504387382

Applicazione
Application DAILY Euro 6E MY.22/24 - FIAGL411

Nota 1
Note 1 82°C

Pompa iniezione
Injection Pump



DUBHE REF. **3404610**

OE Ref. 5802885804

Applicazione
Application DAILY Euro 6E MY.22/24 - FIAGL411

Collettore di distribuzione, Carburante
Distributor Pipe, fuel



DUBHE REF. **341861**

OE Ref. 504371261

Applicazione
Application DAILY Euro 6E MY.22/24 - FIAGL411

Iniettore
Injector Nozzle



DUBHE REF. **340157**

OE Ref. 5802846337

Applicazione
Application DAILY Euro 6E MY.22/24 - FIAGL411

Staffa Bracket



DUBHE REF. **130029**

OE Ref. 5801551667

Applicazione
Application DAILY Euro 6E MY.22/24 - FIAGL411

Turbocompressore, Sovralimentazione Charger, charging system

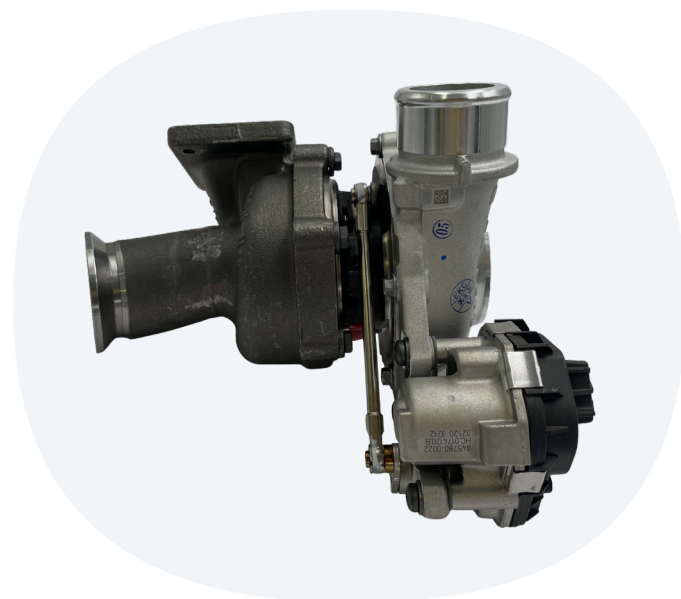

DUBHE REF. **530323**

OE Ref. 5802815821

Applicazione
Application DAILY Euro 6E MY.22/24 - FIAGL411

Guarnizione Gasket



DUBHE REF. **942038**

OE Ref. 5802427803

Applicazione
Application DAILY Euro 6E MY.22/24 - FIAGL411

Giunto di collegamento, Ventilatore radiatore Clutch, radiator fan

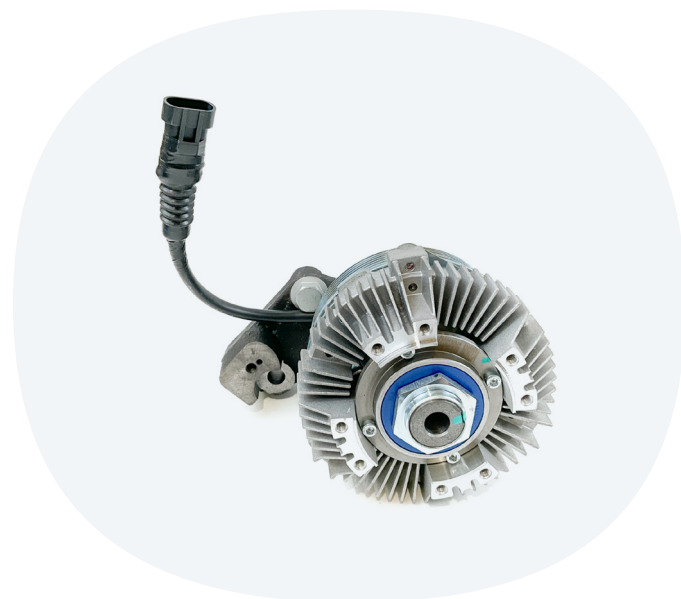

DUBHE REF. **590323M**

OE Ref. 5801974598

Applicazione
Application DAILY Euro 6E MY.22/24 - FIAGL411

Candeletta Glow Plug



DUBHE REF. **9000020**

OE Ref. 5802823579

Applicazione
Application DAILY Euro 6E MY.22/24 - FIAGL411

Compressore, Climatizzatore Compressor, air conditioning



DUBHE REF. **720900**

OE Ref. 5801362246

Applicazione
Application DAILY Euro 6E MY.22/24 - FIAGL411

**Cinghia Poly-V
V-Ribbed Belt**



DUBHE REF.	LEM4EPK903L
OE Ref.	5802102136
Applicazione Application	DAILY Euro 6E MY.22/24 - FIAGL411
Nota 1 Note 1	4EPK x 903 POLI-V